

Normagrup PRO

NORMALUX

Alumbrado de emergencia

NORMALIT

Iluminación técnica y arquitectónica

De profesional
a profesional





Normagrup **PRO**

Hablamos tu mismo lenguaje









Normagrup PRO ofrece una respuesta integral a las necesidades del sector de la iluminación. Un servicio especializado dirigido exclusivamente a los profesionales con un catálogo de productos al mejor precio y un equipo humano preparado para brindar soporte técnico permanente.

NORMALUX Alumbrado de emergencia

Dunna	5	GS	9	Stylo	11	Arque IP44 / IP65	13
							

NORMALIT Iluminación técnica y arquitectónica

Downlight

Polart	18	Polart Q	19		
					
Hat	20	Hat HR	21	Hat Q	21
					
IR	22	IQ	22	Tiny	23
					

Pantallas

Luzerna Avant	24
	

Industrial

Block Avant	26	Hermetic Avant	27
			

Proyectores

Silk	28	Avalon	29
			



Más información:



normalit.es



normalux.es



Normagrup PRO

Un servicio
para profesionales



Relación calidad-precio

Un abanico de productos de alta calidad con los precios más competitivos.



Soporte técnico personalizado

Comunicación directa y 24/7 con un equipo de asesoramiento especializado y personalizado.



Catálogo exclusivo

Un amplio catálogo para dar respuesta integral, rápida y sencilla a cualquier proyecto.



Departamento de ofertas y proyectos a medida

Desarrollo de ejecuciones especiales con soporte técnico de nuestro equipo de ingeniería.



Entrega rápida

Gestión inmediata de pedidos con un plazo máximo de entrega de 40 horas en la península.



Garantía post venta

Garantía de producto de 3 a 5 años y disponibilidad de piezas de recambio durante 10 años.

Dunna

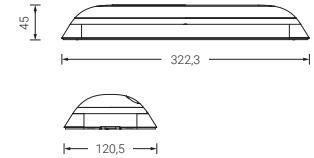

	Lm 45-675				IP 42-44			EN 60598-2-22
	1/2/3				IK 04/07			Alimentación: 127 V · 50/60 Hz.

Acabados

- Blanco
- Antracita Añadir "-1" a la referencia Blanco. Consultar coste adicional.
- Aluminio Añadir "-2" a la referencia Blanco. Consultar coste adicional.

Estándar

NO PERMANENTE MULTILED

IP 44	REF.		LUMEN				PVP (€)
	D-30L	○	45 lm	1 h	0,5	20	26,51 €
	D-60L	○	60 lm	1 h	0,5	20	34,14 €
	D-100L	○	110 lm	1 h	0,5	20	40,93 €
	D-150L	○	140 lm	1 h	0,5	20	46,87 €
	D-200L	○	200 lm	1 h	0,5	20	50,55 €
	D-300L	○	330 lm	1 h	0,5	20	63,81 €
	D-400L	○	400 lm	1 h	0,6	20	75,99 €
	D-500L	○	480 lm	1 h	0,6	20	94,47 €
	D-600L	○	580 lm	1 h	0,7	20	110,43 €
	D2-200L	○	200 lm	2 h	0,6	20	67,18 €
	D2-300L	○	300 lm	2 h	0,7	20	89,43 €
	D2-400L	○	410 lm	2 h	0,7	20	96,04 €
	D2-500L	○	530 lm	2 h	0,7	20	100,73 €
	D3-60L	○	60 lm	3 h	0,5	20	60,19 €
	D3-200L	○	200 lm	3 h	0,6	20	84,44 €
	D3-300L	○	310 lm	3 h	0,7	20	91,94 €
	D-700L	○	675 lm	1 h	0,8	20	126,38 €
IP 42	D3-400L	○	400 lm	3 h	0,8	20	117,64 €

PERMANENTE LED

IP 44	REF.		LUMEN				PVP (€)
	DL-100	○	130 lm	1 h	0,5	20	60,81 €
	DL-150	○	170 lm	1 h	0,5	20	76,45 €
	DL-200	○	230 lm	1 h	0,5	20	92,56 €
	DL-300	○	360 lm	1 h	0,5	20	106,92 €
	DL-400	○	400 lm	1 h	0,6	20	114,14 €
	DL2-200	○	270 lm	2 h	0,5	20	106,19 €
	DL3-100	○	120 lm	3 h	0,6	20	106,19 €
	DL3-300	○	335 lm	3 h	0,7	20	121,95 €
	DL-500	○	480 lm	1 h	0,8	20	132,62 €
IP 42	DL3-60	○	60 lm	3 h	0,6	20	82,66 €

PERMANENTE MULTILED

IP 44	REF.		LUMEN				PVP (€)
	DL-60M	○	70 lm	1 h	0,5	20	50,68 €
	DL-150M	○	145 lm	1 h	0,5	20	59,26 €
	DL-200M	○	170 lm	1 h	0,5	20	66,17 €
	DL-300M	○	325 lm	1 h	0,6	20	88,84 €
	DL3-150M	○	160 lm	3 h	0,6	20	91,97 €

Disponible en 127V 50/60Hz. Indicar referencia + V. Consultar coste adicional
 Disponible en 24Vcc. Indicar referencia + C. Consultar coste adicional

Autotest

NO PERMANENTE MULTILED

IP 44	REF.		LUMEN				PVP (€)
	DA-60L	○	70 lm	1 h	0,5	20	46,06 €
	DA-100L	○	135 lm	1 h	0,5	20	52,85 €
	DA-150L	○	145 lm	1 h	0,5	20	58,80 €
	DA-200L	○	195 lm	1 h	0,5	20	62,48 €
	DA-300L	○	290 lm	1 h	0,5	20	75,73 €
	DA-400L	○	390 lm	1 h	0,6	20	87,92 €
	DA-500L	○	490 lm	1 h	0,6	20	106,41 €
	DA-600L	○	650 lm	1 h	0,7	20	122,35 €
	DA2-200L	○	210 lm	2 h	0,5	20	79,11 €
	DA2-300L	○	290 lm	2 h	0,6	20	85,10 €
	DA2-400L	○	400 lm	2 h	0,7	20	126,47 €
	DA3-100L	○	100 lm	3 h	0,5	20	67,15 €
	DA3-200L	○	180 lm	3 h	0,6	20	96,36 €
	DA3-300L	○	290 lm	3 h	0,7	20	105,33 €
	DA3-500L	○	520 lm	3 h	0,8	20	129,55 €

PERMANENTE MULTILED

IP 44	REF.		LUMEN				PVP (€)
	DAL-60M	○	85 lm	1 h	0,5	20	62,60 €
	DAL-100M	○	92 lm	1 h	0,5	20	72,72 €
	DAL-200M	○	210 lm	1 h	0,5	20	78,09 €
	DAL-300M	○	300 lm	1 h	0,5	20	88,84 €
	DAL2-200M	○	200 lm	2 h	0,5	20	78,09 €
	DAL3-100M	○	120 lm	3 h	0,5	20	88,84 €
	DAL3-200M	○	200 lm	3 h	0,6	20	93,51 €

Disponible en 127V 50/60Hz. Indicar referencia + V. Consultar coste adicional
Disponible en 24Vcc. Indicar referencia + C. Consultar coste adicional

ACCESORIOS

DIFUSOR DE BANDEROLA

DUNNA + D-DB



DUNNA + D-DBL



REF.			PVP (€)
D-DB	Difusor de banderola. Dimensiones 332x132 mm.	20	24,18 €
D-DBL	Difusor de banderola alto. Dimensiones 332x243 mm. Apta para pictogramas tipo PDUL	12	33,89 €

D-DB

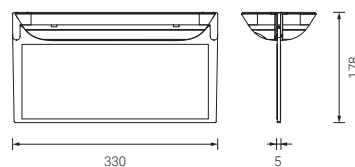

D-DBL

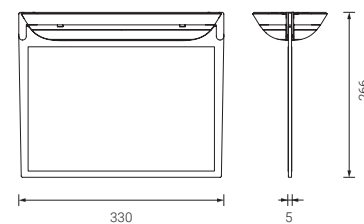

MARCOS EMPOTRABLES

DUNNA + D-MEL



DUNNA + D-MEP



D-MEL	Marco para empotrar a techo técnico o pared de yeso laminado. Color blanco	20	7,69 €
D-MEP	Conjunto de marco y caja para empotrar a pared. Color blanco	20	9,98 €

D-MEL

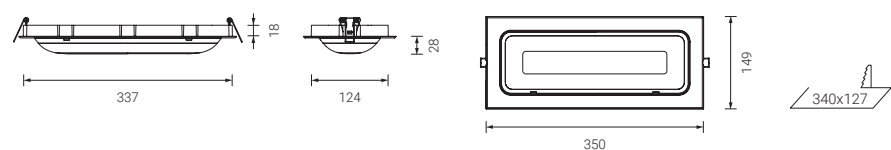

D-MEP

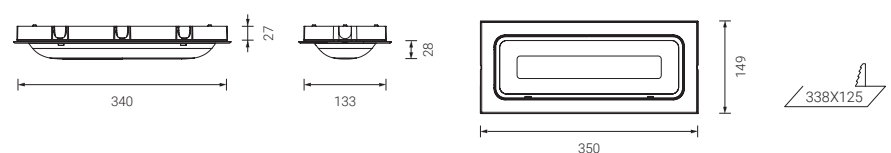

ACCESORIOS

MARCOS EMPOTRABLES
CON DIFUSOR DE BANDEROLA



REF.		☐	PVP (€)
D-DBEL	Marco de empotrar a techo y difusor de banderola. Apta para pictogramas tipo N y LN. Color blanco	12	26,85 €
D-DBELL	Marco de empotrar a techo y difusor de banderola larga. Apta para pictogramas tipo PDUL. Color blanco	12	36,56 €

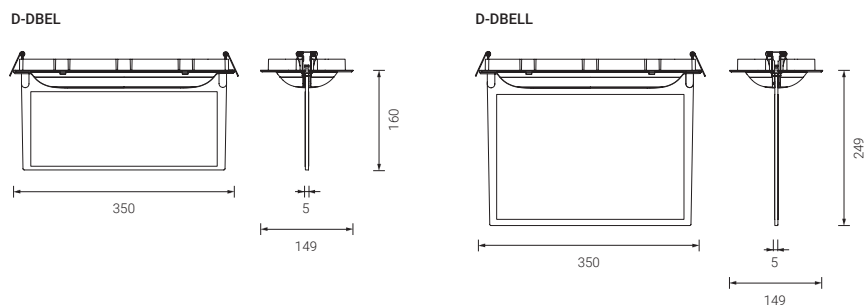

ADAPTADOR TUBO



D-AT	Adaptador para el montaje de un tubo de métrica 20	20	1,24 €
------	--	----	--------

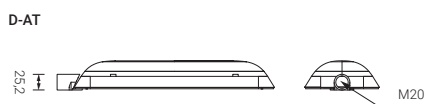

ENVOLVENTES ESTANCAS



D-MS	Envolvente estanca IP-66, IK-10	20	20,19 €
DM-DB	Envolvente estanca IP-65, IK-07 con difusor banderola	20	28,29 €

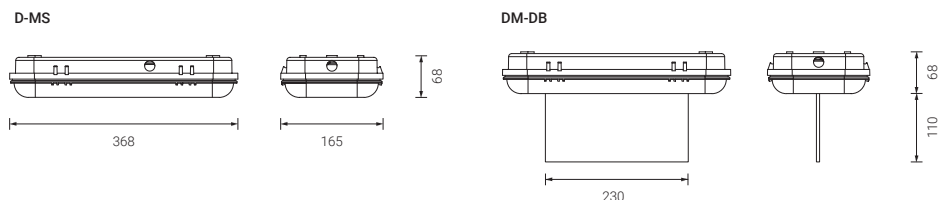

SOPORTES DE FIJACIÓN

U-SBL	Brazo para la fijación a pared		10,41 €
U-AV	Cierre antivandálico		32,00 €
D-KS	Kit suspensión, 300 mm		20,43 €

TELEMANDOS





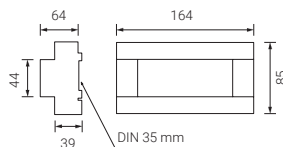











S-TE	Telemando para el control de hasta 300 equipos estándar o autotest		140,83 €
------	--	--	----------



ACCESORIOS

	REF.		PVP (€)
PICTOGRAMAS	Tipo N	Pictograma adhesivo de 150 x 90 mm. <i>Referencia según la tabla adjunta</i>	2,15 €
	Tipo LN	Pictograma adhesivo de 230 x 110 mm. Solo para uso en banderola DM-DB. <i>Referencia según la tabla adjunta</i>	2,15 €
	Tipo PDU	Pictograma no adhesivo de 300 x 120 mm. Solo para uso en banderola D-DB / D-DBEL. <i>Referencia según la tabla adjunta</i>	2,70 €
	Tipo PDUL	Pictograma no adhesivo de 210 x 210 mm. <i>Referencia según la tabla adjunta</i>	2,70 €

Tipo N 150 x 90 mm	REF. N-L  REF. N-R  REF. N-SD  REF. N-SU 	Distancia máxima de visión (según EN 1838 para señales iluminadas interiormente)	18 m
Tipo LN 230 x 110 mm	REF. LN-L  REF. LN-R  REF. LN-SD  REF. LN-SU 	Distancia máxima de visión (según EN 1838 para señales iluminadas interiormente)	22 m
Tipo PDU 300 x 120 mm	REF. PDU-A  REF. PDU-R  REF. PDU-SD  REF. PDU-SU 	Distancia máxima de visión (según EN 1838 para señales iluminadas interiormente)	24 m
Tipo PDUL 210 x 210 mm	REF. PDUL-BIE  REF. PDUL-EXT  REF. PDUL-PUL 	Distancia máxima de visión (según CTE)	10 m

GS

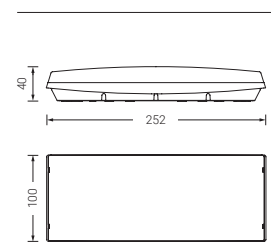

MÁXIMA COMPATIBILIDAD DE INSTALACIÓN

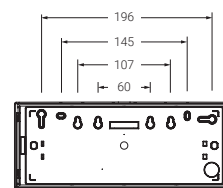

Estándar

NO PERMANENTE

IP 44	REF.		LUMEN				PVP (€)
	G-60L	○	70 lm	1 h	0,3	30	25,56 €
	G-100L	○	110 lm	1 h	0,3	30	28,97 €
	G-150L	○	150 lm	1 h	0,3	30	32,38 €
	G-200L	○	210 lm	1 h	0,3	30	36,83 €
	G-300L	○	325 lm	1 h	0,4	30	47,71 €
	G-400L	○	400 lm	1 h	0,4	30	61,41 €
	G-500L	○	500 lm	1 h	0,4	30	78,40 €
	G2-100L	○	126 lm	2 h	0,3	30	35,04 €
	G2-300L	○	305 lm	2 h	0,4	30	57,24 €
	G3-100L	○	130 lm	3 h	0,4	30	47,71 €
	G3-200L	○	200 lm	3 h	0,4	30	57,24 €

PERMANENTE

IP 44	REF.		LUMEN				PVP (€)
	GL-60	○	80 lm	1 h	0,3	30	46,02 €
	GL-100	○	100 lm	1 h	0,3	30	47,71 €
	GL-150	○	170 lm	1 h	0,3	30	50,90 €
	GL-200	○	200 lm	1 h	0,3	30	54,53 €
	GL-300	○	300 lm	1 h	0,4	30	64,32 €
	GL-400	○	400 lm	1 h	0,4	30	76,49 €
	GL3-100	○	110 lm	3 h	0,4	30	64,32 €

Consulte disponibilidad en 127V 50/60Hz. Indicar referencia + V.
Consultar coste adicional

Autotest

NO PERMANENTE

IP 44	REF.		LUMEN				PVP (€)
	GA-60L	○	70 lm	1 h	0,3	30	39,61 €
	GA-100L	○	130 lm	1 h	0,3	30	44,57 €
	GA-150L	○	170 lm	1 h	0,3	30	49,43 €
	GA-200L	○	200 lm	1 h	0,3	30	56,41 €
	GA-300L	○	310 lm	1 h	0,4	30	67,99 €
	GA-300L-MH	○	310 lm	1 h	0,4	30	78,58 €
	GA-400L	○	465 lm	1 h	0,4	30	79,74 €
	GA-500L	○	500 lm	1 h	0,4	30	98,22 €
	GA2-150L	○	170 lm	2 h	0,4	30	64,75 €
	GA2-300L	○	310 lm	2 h	0,4	30	77,51 €
	GA3-200L	○	195 lm	3 h	0,4	30	77,51 €

PERMANENTE

IP 44	REF.		LUMEN				PVP (€)
	GAL-60	○	75 lm	1 h	0,3	20	69,73 €
	GAL-150	○	155 lm	1 h	0,3	30	74,06 €
	GAL-200	○	190 lm	1 h	0,3	30	96,50 €
	GAL-300	○	310 lm	1 h	0,3	30	107,78 €

Consulte disponibilidad en 127V 50/60Hz. Indicar referencia + V.
Consultar coste adicional

ACCESORIOS

DIFUSOR DE BANDEROLA



GS + G-DB
+ Pictograma Tipo PD



GS + G-ME + G-DBE
+ Pictograma Tipo PD



GS + G-DBP
+ Pictograma Tipo LN



GS + G-ME + G-DBPE
+ Pictograma Tipo LN

MARCOS EMPOTRABLES

KIT Y ENVOLVENTE DE ESTANQUEIDAD

ADAPTADOR

TELEMANDOS

PICTOGRAMAS

OTROS PICTOGRAMAS
A CONSULTAR

REF.		PVP (€)
G-DB	Difusor de banderola. Compatible con todos los equipos de la serie GS	14,57 €
G-DBE	Difusor de banderola empotrable a techo. Compatible todos los equipos de la serie GS que incluyan el accesorio G-ME	17,17 €
G-DBP	Difusor de banderola a pared (superficie). Compatible con todos los equipos de la serie GS	17,17 €
G-DBPE	Difusor de banderola empotrable a pared. Compatible todos los equipos de la serie GS que incluyan el accesorio G-ME	17,17 €

S-ME	Marco para empotrar los equipos de la serie GS	5,85 €
------	--	--------

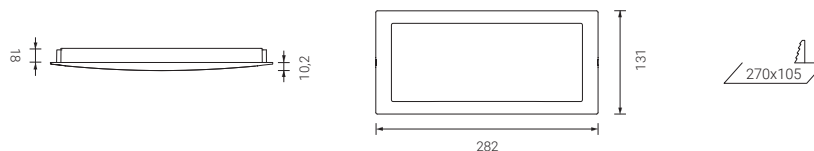

G-AMS	Kit de estanqueidad (IP65) compuesto por junta de estanqueidad, prensaestopa PG7 y juntas para tornillos	9,82 €
G-MS	Envolvente estanca IP68 e IK08 para equipos de la familia GS	20,19 €

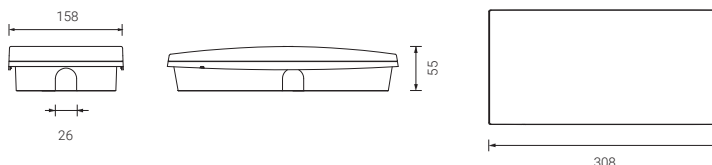

O-AT	Adaptador para el montaje de tubo de M20. No mantiene IP67	1,36 €
------	--	--------

S-TE	Telemando para el control de hasta 300 equipos estándar o autotest	140,83 €
------	--	----------

Tipo PD	Pictograma no adhesivo de 240 x 120 mm. Referencia según la tabla adjunta	2,70 €
---------	---	--------

Tipo PD
240 x 120 mm



Distancia máxima de visión
(según EN 1838 para señales
iluminadas interiormente)

24 m

Stylo

CE RoHS LED

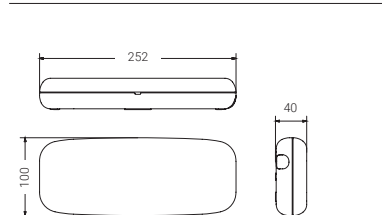

Estándar

NO PERMANENTE

IP 44	REF.		LUMEN				PVP (€)
	S-30L	○	40 lm	1 h	0,4	20	26,51 €
	S-60L	○	70 lm	1 h	0,4	20	34,11 €
	S-100L	○	115 lm	1 h	0,4	20	40,93 €
	S-150L	○	145 lm	1 h	0,4	20	46,87 €
	S-200L	○	195 lm	1 h	0,4	20	50,55 €
	S-300L	○	320 lm	1 h	0,4	20	63,65 €
	S-400L	○	385 lm	1 h	0,4	20	75,76 €
	S-500L	○	500 lm	1 h	0,4	20	94,47 €
	S2-200L	○	270 lm	2 h	0,4	20	67,01 €
	S3-100L	○	125 lm	3 h	0,4	20	63,65 €

PERMANENTE

IP 44	REF.		LUMEN				PVP (€)
	SL-60M	○	80 lm	1 h	0,4	20	50,44 €
	SL-150M	○	160 lm	1 h	0,4	20	63,93 €
	SL-200M	○	195 lm	1 h	0,4	20	77,99 €
	SL-300M	○	280 lm	1 h	0,4	20	89,61 €
	SL-400M	○	375 lm	1 h	0,4	20	101,79 €
	SL3-100M	○	105 lm	3 h	0,4	20	89,61 €

Disponible en 127V 50/60Hz. Indicar referencia + V. Consultar coste adicional
 Disponible en 24Vcc. Indicar referencia + C. Consultar coste adicional

Autotest

NO PERMANENTE

IP 44	REF.		LUMEN				PVP (€)
	SA-60L	○	70 lm	1 h	0,4	20	40,79 €
	SA-100L	○	125 lm	1 h	0,4	20	45,91 €
	SA-150L	○	160 lm	1 h	0,4	20	50,91 €
	SA-200L	○	195 lm	1 h	0,4	20	58,09 €
	SA-300L	○	290 lm	1 h	0,4	20	70,02 €
	SA-400L	○	440 lm	1 h	0,4	20	82,14 €
	SA-500L	○	495 lm	1 h	0,4	20	100,62 €
	SA2-150L	○	160 lm	2 h	0,4	20	71,07 €
	SA3-200L	○	185 lm	3 h	0,4	20	79,83 €

PERMANENTE

IP 44	REF.		LUMEN				PVP (€)
	SAL-60M	○	75 lm	1 h	0,4	20	62,36 €
	SAL-150M	○	160 lm	1 h	0,4	20	75,86 €
	SAL-200M	○	195 lm	1 h	0,4	20	89,91 €
	SAL-300M	○	290 lm	1 h	0,4	20	101,55 €

Disponible en 127V 50/60Hz. Indicar referencia + V. Consultar coste adicional
 Disponible en 24Vcc. Indicar referencia + C. Consultar coste adicional

ACCESORIOS

DIFUSOR DE BANDEROLA



STYLO + S-DB
+ Pictograma Tipo PD



STYLO + S-ME + S-DBE
+ Pictograma Tipo PD



STYLO + S-DBP
+ Pictograma Tipo LN



STYLO + S-ME + S-DBPE
+ Pictograma Tipo LN

MARCOS EMPOTRABLES

Válido para techo y pared de hormigón

S-ME



REF.		PVP (€)
S-DB	Difusor de banderola. Compatible con todos los equipos de la serie STYLO	14,57 €
S-DBE	Difusor de banderola empotrable. Compatible todos los equipos de la serie STYLO que incluyan el accesorio S-ME	17,17 €
S-DBP	Difusor de banderola para pared (superficie). Compatible con todos los equipos de la serie STYLO	17,17 €
S-DBPE	Difusor de banderola empotrable en pared. Compatible todos los equipos de la serie STYLO que incluyan el accesorio S-ME	17,17 €

S-ME	Marco para empotrar los equipos de la serie STYLO	20	8,66 €
------	---	----	--------

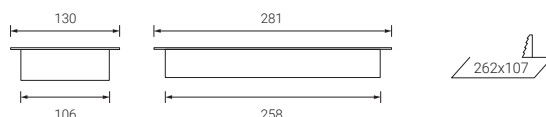

SUSENSIONES TECHO Y PARED

S-KS

U-SBC + S-DB



S-KS	Suspensión al techo con varillas de aluminio (2 und.), de 300 mm de longitud	58,56 €
U-SBC	Brazo de fijación a pared	10,41 €

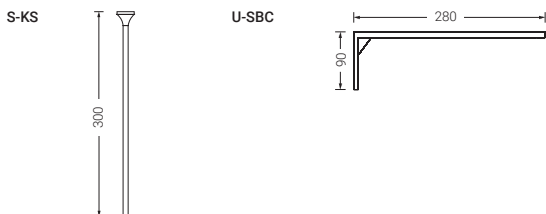

ENVOLVENTES ESTANCAS

S-MS



S-MS	Envolvente estanca IP-65, IK-07 para los equipos de la serie STYLO	20	20,19 €
------	--	----	---------

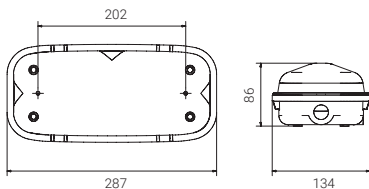

TELEMANDOS

S-TE	Telemando para el control de hasta 300 equipos estándar o autotest	140,83 €
------	--	----------

REJILLA DE PROTECCIÓN

U-AV	Cierre antivandálico universal de 37 x 19,8 x 9 cm para el resto de equipos de la serie STYLO	32,00 €
------	---	---------

PICTOGRAMAS

Tipo PD	Pictograma no adhesivo de 240 x 120 mm. Referencia según la tabla adjunta	2,70 €
---------	---	--------

OTROS PICTOGRAMAS
A CONSULTAR

Tipo PD
240 x 120 mm



Distancia máxima de visión
(según EN 1838 para señales
iluminadas interiormente)

24 m

Arque IP44

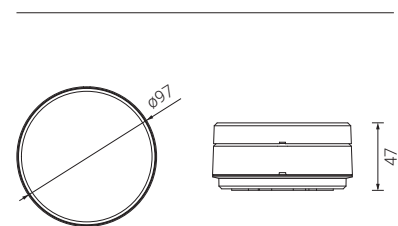

Difusor transparente

	Lm 85-500				IP 44		230 Vac		EN 60598-2-22
	1/3				IK 09		24 Vdc		
					LiFePO4				

Acabados

- Blanco
 - Negro
- Añadir "-4" a la referencia Blanco. Consultar coste adicional.

Difusor transparente

Estándar

NO PERMANENTE MULTILED

IP 44	REF.		LUMEN				PVP (€)
	QS-100L	○	90 lm	1 h	0,2	20	47,82 €
	QV-100L	○	90 lm	1 h	0,2	20	47,82 €
	QS-200L	○	200 lm	1 h	0,2	20	56,74 €
	QV-200L	○	200 lm	1 h	0,2	20	56,74 €
	QS-300L	○	280 lm	1 h	0,2	20	66,94 €
	QV-300L	○	280 lm	1 h	0,2	20	66,94 €
	QS3-100L	○	100 lm	3 h	0,2	20	59,57 €
	QV3-100L	○	100 lm	3 h	0,2	20	59,57 €

PERMANENTE / NO PERMANENTE MULTILED

IP 44	REF.		LUMEN				PVP (€)
	QSL-100 *	○	90 lm	1 h	0,2	20	56,42 €
	QVL-100 *	○	90 lm	1 h	0,2	20	56,42 €
	QSL-200	○	200 lm	1 h	0,2	20	65,89 €
	QVL-200	○	200 lm	1 h	0,2	20	65,89 €
	QSL3-100	○	125 lm	3 h	0,2	20	68,71 €
	QVL3-100	○	125 lm	3 h	0,2	20	68,71 €

* No compatibles con telemando S-TE

Autotest

NO PERMANENTE MULTILED

IP 44	REF.		LUMEN				PVP (€)
	QSA-100L	○	90 lm	1 h	0,2	20	60,40 €
	QVA-100L	○	90 lm	1 h	0,2	20	60,40 €
	QSA-200L	○	185 lm	1 h	0,2	20	69,32 €
	QVA-200L	○	185 lm	1 h	0,2	20	69,32 €
	QSA-300L	○	280 lm	1 h	0,2	20	79,52 €
	QVA-300L	○	280 lm	1 h	0,2	20	79,52 €
LiFePO4	QSA-500LLi	○	500 lm	1 h	0,2	20	112,23 €
LiFePO4	QVA-500LLi	○	500 lm	1 h	0,2	20	112,23 €

PERMANENTE / NO PERMANENTE MULTILED

IP 44	REF.		LUMEN				PVP (€)
LiFePO4	QSAL-150Li	○	130 lm	1 h	0,2	20	76,47 €
LiFePO4	QVAL-150Li	○	130 lm	1 h	0,2	20	76,47 €
LiFePO4	QSAL-250Li	○	235 lm	1 h	0,2	20	81,00 €
LiFePO4	QVAL-250Li	○	235 lm	1 h	0,2	20	81,00 €

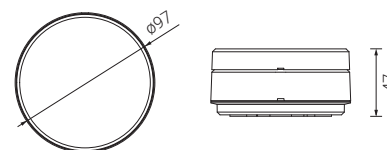

Difusor opal

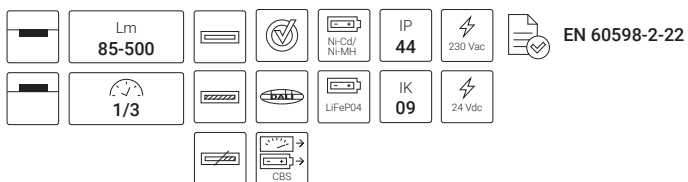

Acabados

- Blanco
- Negro Añadir "-4" a la referencia Blanco. Consultar coste adicional.

Difusor opal

Estándar

NO PERMANENTE MULTILED

IP 44	REF.	LUMEN	1 h	0,2	20	PVP (€)
	Q-100L	85 lm	1 h	0,2	20	39,94 €
	Q-200L	190 lm	1 h	0,2	20	48,87 €
	Q-300L	260 lm	1 h	0,2	20	59,06 €
	Q3-100L	95 lm	3 h	0,2	20	51,69 €

PERMANENTE / NO PERMANENTE MULTILED

IP 44	REF.	LUMEN	1 h	0,2	20	PVP (€)
	QL-100	85 lm	1 h	0,2	20	48,54 €
	QL-100W	80 lm	1 h	0,2	20	52,40 €
	QL-200	190 lm	1 h	0,2	20	58,01 €
	QL-200W	180 lm	1 h	0,2	20	61,78 €
	QL-300	285 lm	1 h	0,2	20	68,21 €
	QL-300W	260 lm	1 h	0,2	20	Consultar
	QL3-100	120 lm	3 h	0,2	20	60,84 €
	QL3-100W	75 lm	3 h	0,5	20	64,70 €

Ref. -W = 3000 K

Autotest

NO PERMANENTE MULTILED

IP 44	REF.	LUMEN	1 h	0,2	20	PVP (€)
	QA-100L	85 lm	1 h	0,2	20	52,52 €
	QA-200L	175 lm	1 h	0,2	20	61,45 €
	QA-300L	265 lm	1 h	0,2	20	71,64 €
	LiFePO4 QA-500LLi	475 lm	1 h	0,2	20	104,35 €
	LiFePO4 QA3-250LLi	220 lm	3 h	0,2	20	79,00 €

PERMANENTE / NO PERMANENTE MULTILED

IP 44	REF.	LUMEN	1 h	0,2	20	PVP (€)
	LiFePO4 QAL-150Li	125 lm	1 h	0,2	20	68,60 €
	LiFePO4 QAL-150LiW	115 lm	1 h	0,2	20	72,46 €
	LiFePO4 QAL-250Li	225 lm	1 h	0,2	20	73,12 €
	LiFePO4 QAL-250LiW	195 lm	1 h	0,2	20	76,98 €

Ref. -W = 3000 K

Arque IP65

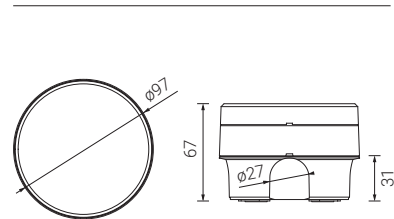

Difusor transparente

Acabados

- Blanco
- Negro Añadir "-4" a la referencia Blanco. Consultar coste adicional.

Difusor transparente

Estándar

NO PERMANENTE MULTILED

IP 65	REF.	LUMEN	⌚	🔋	📦	PVP (€)
	QSE-100L	90 lm	1 h	0,2	6	51,56 €
	QVE-100L	90 lm	1 h	0,2	6	51,56 €
	QSE-200L	200 lm	1 h	0,2	6	60,48 €
	QVE-200L	200 lm	1 h	0,2	6	60,48 €
	QSE-300L	280 lm	1 h	0,2	6	70,68 €
	QVE-300L	280 lm	1 h	0,2	6	70,68 €
	QSE3-100L	100 lm	3 h	0,2	6	63,30 €
	QVE3-100L	100 lm	3 h	0,2	6	63,30 €

PERMANENTE / NO PERMANENTE MULTILED

IP 65	REF.	LUMEN	⌚	🔋	📦	PVP (€)
	QSEL-100 *	90 lm	1 h	0,2	6	60,15 €
	QVEL-100 *	90 lm	1 h	0,2	6	60,15 €
	QSEL-200	200 lm	1 h	0,2	6	69,63 €
	QVEL-200	200 lm	1 h	0,2	6	69,63 €
	QSEL3-100	125 lm	3 h	0,2	6	72,45 €
	QVEL3-100	125 lm	3 h	0,2	6	72,45 €

* No compatibles con telemando S-TE

Autotest

NO PERMANENTE MULTILED

IP 65	REF.	LUMEN	⌚	🔋	📦	PVP (€)
	QSEA-100L	90 lm	1 h	0,2	6	64,13 €
	QVEA-100L	90 lm	1 h	0,2	6	64,13 €
	QSEA-200L	185 lm	1 h	0,2	6	73,06 €
	QVEA-200L	185 lm	1 h	0,2	6	73,06 €
	QSEA-300L	280 lm	1 h	0,2	6	83,25 €
	QVEA-300L	280 lm	1 h	0,2	6	83,25 €
LiFePO4	QSEA-500LLi	500 lm	1 h	0,2	6	115,96 €
LiFePO4	QVEA-500LLi	500 lm	1 h	0,2	6	115,96 €

PERMANENTE / NO PERMANENTE MULTILED

IP 65	REF.	LUMEN	⌚	🔋	📦	PVP (€)
LiFePO4	QSEAL-150Li	150 lm	1 h	0,9	6	80,21 €
LiFePO4	QVEAL-150Li	150 lm	1 h	0,9	6	80,21 €
LiFePO4	QSEAL-250Li	235 lm	1 h	0,9	6	84,74 €
LiFePO4	QVEAL-250Li	235 lm	1 h	0,9	6	84,74 €

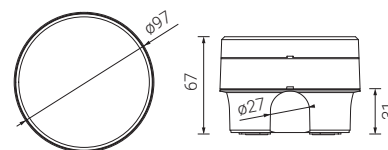

Difusor opal

	Lm 85-500				Ni-Cd/ Ni-MH		IP 65		230 Vac		EN 60598-2-22
	1/3				LiFePO4		IK 09		24 Vdc		CBS

Acabados

- Blanco
 - Negro
- Añadir "-4" a la referencia Blanco.
Consultar coste adicional.

Difusor opal

Estándar

NO PERMANENTE MULTILED

IP 65	REF.		LUMEN				PVP (€)
	QE-100L	○	85 lm	1 h	0,2	6	43,68 €
	QE-200L	○	190 lm	1 h	0,2	6	52,60 €
	QE-300L	○	260 lm	1 h	0,2	6	62,80 €
	QE3-100L	○	95 lm	3 h	0,2	6	55,43 €

PERMANENTE / NO PERMANENTE MULTILED

IP 65	REF.		LUMEN				PVP (€)
	QEL-100	○	85 lm	1 h	0,2	6	52,28 €
	QEL-200	○	190 lm	1 h	0,2	6	61,75 €
	QEL3-100	○	120 lm	3 h	0,2	6	Consultar

Ref. -W = 3000 K

Autotest

NO PERMANENTE MULTILED

IP 65	REF.		LUMEN				PVP (€)
	QEA-100L	○	85 lm	1 h	0,2	6	56,26 €
	QEA-200L	○	175 lm	1 h	0,2	6	65,18 €
	QEA-300L	○	265 lm	1 h	0,2	6	75,38 €
LiFePO4	QEA-500LLi	○	475 lm	1 h	0,2	6	108,09 €

PERMANENTE / NO PERMANENTE MULTILED

IP 65	REF.		LUMEN				PVP (€)
LiFePO4	QEAL-150Li	○	140 lm	1 h	0,2	6	72,33 €
LiFePO4	QEAL-250Li	○	225 lm	1 h	0,2	6	76,86 €

Ref. -W = 3000 K

ACCESORIOS

DIFUSOR DE BANDEROLA

ARQUE + Q-DB



ARQUE +Q-DBL



ARQUE + Q-DBE



ARQUE + Q-DBEL



MARCOS EMPOTRABLES

ARQUE + Q-ME + Q-DB



SOPORTE DE FIJACIÓN

ARQUE + Q-SB + Q-DB



ARQUE + Q-SB + Q-DBL



ENVOLVENTE ESTANCA

TELEMANDOS

PICTOGRAMAS

OTROS PICTOGRAMAS
A CONSULTAR

REF.			PVP (€)
Arque IP44	Q-DB	Difusor de banderola para equipos compatibles con la serie Arque IP44. Apta pictogramas Tipo PQ	20 24,61 €
	Q-DBL	Difusor de banderola para equipos compatibles con la serie Arque IP44. Apta pictogramas Tipo PQL	20 29,50 €

Arque IP65	Q-DBE	Difusor de banderola para equipos compatibles con la serie Arque IP65. Apta pictogramas Tipo PQ	20 24,61 €
	Q-DBEL	Difusor de banderola para equipos compatibles con la serie Arque IP65. Apta pictogramas Tipo PQL	20 29,50 €

Arque IP44	Q-ME	Marco de empotrar compatible con la serie Arque IP44	20 8,97 €
Arque IP65	Q-MES	Marco de empotrar compatible con la serie Arque IP65	20 8,97 €

Q-SB	Brazo para fijación a pared	21,90 €
------	-----------------------------	---------

Q-MS	Base estanca
------	--------------

S-TE	Telemando para el control de hasta 300 equipos estándar o autotest	140,83 €
------	--	----------

Tipo PQ	Pictograma de 200x100 mm. Referencia según la tabla adjunta	2,20 €
---------	---	--------

Tipo PQL	Pictograma de 300x150 mm. Referencia según la tabla adjunta	2,80 €
----------	---	--------

Tipo PQ
200 x 100 mm



Distancia máxima de visión
(según EN 1838 para señales
iluminadas interiormente)

20 m

Tipo PQL
300 x 150 mm



Distancia máxima de visión
(según EN 1838 para señales
iluminadas interiormente)

30 m

Polart



Empotrado a techo

LED CE RoHS

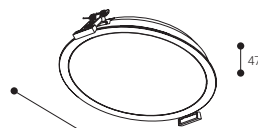

Polart: 223
Polart Mini: 150
Polart Micro: 110

Distancia mínima de instalación a techo
97

Rango de escotadura

Polart	Ø200-218
Polart Mini	Ø129-145
Polart Micro	Ø95-105

72000 h.
L80B10

CRI >80

114°

Rendimiento (%)

Polart	74,1
Polart Mini	72,6
Polart Micro	71,7

Seguridad fotobiológica

RG0 Exento de riesgo

○ RAL9003

DIFUSOR OPAL

Polart

IP 20-50 | UGR 22



K	REF.	W	LUMEN	Beam	UGR	PVP (€)
3000	PO23B	18 W	2613 lm	○ 0,5		39,75 €
4000	PO24B	18 W	2750 lm	○ 0,5		39,75 €
5000	PO25B	18 W	2790 lm	○ 0,5		39,75 €

Selector de temperatura de color

K	REF.	W	LUMEN	Beam	UGR	PVP (€)
3000	PO2XB	18 W	2750 lm	○ 0,5		47,00 €

Polart Mini

IP 20-50 | UGR 22



K	REF.	W	LUMEN	Beam	UGR	PVP (€)
3000	PM13B	9 W	1330 lm	○ 0,3		32,25 €
4000	PM14B	9 W	1400 lm	○ 0,3		32,25 €
5000	PM15B	9 W	1420 lm	○ 0,3		32,25 €

Selector de temperatura de color

K	REF.	W	LUMEN	Beam	UGR	PVP (€)
3000	PM1XB	9 W	1400 lm	○ 0,3		39,50 €

Polart Micro

IP 20-50 | UGR 22



K	REF.	W	LUMEN	Beam	UGR	PVP (€)
3000	PP03B	4 W	637 lm	○ 0,17		25,75 €
4000	PP04B	4 W	670 lm	○ 0,17		25,75 €
5000	PP05B	4 W	680 lm	○ 0,17		25,75 €

Selector de temperatura de color

K	REF.	W	LUMEN	Beam	UGR	PVP (€)
3000	PP0XB	4 W	670 lm	○ 0,17		33,00 €

ACCESORIOS

Accesorio instalación superficie

Modelo	Descripción	PVP (€)
POSB	Superficie Polart	10,00 €
PMSB	Superficie Polart mini	9,25 €
PPSB	Superficie Polart Micro	6,80 €

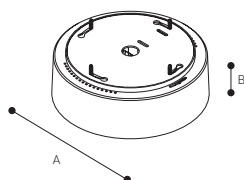

	mm	
	A	B
Polart	226	75
Polart Mini	153	84
Polart Micro	113	84

! NO COMPATIBLES CON VERSIÓN DALI

Polart Q



Empotrado a techo

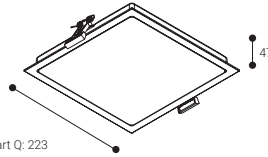

Polart Q: 223
Polart Mini Q: 150
Polart Micro Q: 110

Distancia mínima de instalación a techo
97

Rango de escotadura

Polart Q	200x200-218x218
Polart Mini Q	129x129-145x145
Polart Micro Q	95x95-105x105

72000 h. L80B10 | CRI >80 | 114°

Rendimiento (%)

Polart Q	79
Polart Mini Q	67,8
Polart Micro Q	71,4

Seguridad fotobiológica

RG0 0 Exento de riesgo

RAL9003

DIFUSOR OPAL

Polart Q

IP 20-50 | UGR 22



K	REF.	W	LUMEN	Icon	Icon	PVP (€)
3000	POQ23B	17 W	2613 lm	○	0,5	45,75 €
4000	POQ24B	17 W	2750 lm	○	0,5	45,75 €
5000	POQ25B	17 W	2790 lm	○	0,5	45,75 €

Selector de temperatura de color

K	REF.	W	LUMEN	Icon	Icon	PVP (€)
3000	POQ2XB	17 W	2750 lm	○	0,5	53,00 €
4000						
5000						

Polart Mini Q

IP 20-50 | UGR 22



K	REF.	W	LUMEN	Icon	Icon	PVP (€)
3000	PMQ13B	9 W	1330 lm	○	0,3	36,25 €
4000	PMQ14B	9 W	1400 lm	○	0,3	36,25 €
5000	PMQ15B	9 W	1420 lm	○	0,3	36,25 €

Selector de temperatura de color

K	REF.	W	LUMEN	Icon	Icon	PVP (€)
3000	PMQ1XB	9 W	1400 lm	○	0,3	43,50 €
4000						
5000						

Polart Micro Q

IP 20-50 | UGR 22



K	REF.	W	LUMEN	Icon	Icon	PVP (€)
3000	PPQ03B	4 W	637 lm	○	0,17	27,75 €
4000	PPQ04B	4 W	670 lm	○	0,17	27,75 €
5000	PPQ05B	4 W	680 lm	○	0,17	27,75 €

Selector de temperatura de color

K	REF.	W	LUMEN	Icon	Icon	PVP (€)
3000	PPQ0XB	4 W	670 lm	○	0,17	35,00 €
4000						
5000						

ACCESORIOS

Accesorio instalación superficie	PVP (€)
POQSB Superficie Polart Q	11,00 €
PMQSB Superficie Polart Mini Q	9,75 €
PPQSB Superficie Polart Micro Q	7,00 €

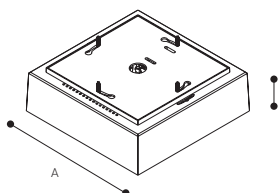

	mm	
	A	B
Polart Q	226	75
Polart Mini Q	153	84
Polart Micro Q	113	84

NO COMPATIBLES CON VERSIÓN DALI

Hat

Empotrado a techo

LED CE RoHS

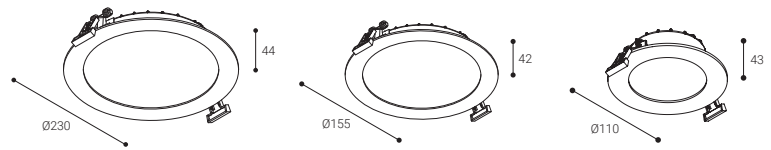

Distancia mínima de instalación a techo
94

	Rango de escotadura	Escotadura ideal
Hat	Ø200-225	Ø210 Corte redondo
Hat Mini	Ø125-150	Ø135 Corte redondo
Hat Micro	Ø92-105	Ø100 Corte redondo

EH1 54000 h. L70B10	EH2/EHM/EHP 72000 h. L70B10	CRI >80	EH/EHP 84°	EHM 85°
---------------------------	-----------------------------------	------------	---------------	------------

Rendimiento (%)

Hat	75,1
Hat Mini	69,2
Hat Micro	75,1

Seguridad fotobiológica
RG0 Exento de riesgo

- RAL9016
- RAL7001 Sustituir "B" por "G" en la referencia
- RAL9005 Sustituir "B" por "N" en la referencia

DIFUSOR MICROSPRISMÁTICO

Hat

IP 20-54 | UGR 22



K	REF.	W	LUMEN				PVP (€)
3000	EH13B	13 W	1500 lm	○	0,8	18	40,53 €
	EH23B	20,5 W	2300 lm	○	0,8	18	45,99 €
4000	EH14B	13 W	1600 lm	○	0,8	18	40,53 €
	EH24B	20,5 W	2400 lm	○	0,8	18	45,99 €
5000	EH15B	13 W	1625 lm	○	0,8	18	40,53 €
	EH25B	20,5 W	2430 lm	○	0,8	18	45,99 €
6000	EH16B	13 W	1625 lm	○	0,8	18	40,53 €
	EH26B	20,5 W	2435 lm	○	0,8	18	45,99 €

Hat Mini

IP 20-54 | UGR 22



K	REF.	W	LUMEN				PVP (€)
3000	EHM13B	10,9 W	1400 lm	○	0,3		39,24 €
4000	EHM14B	10,9 W	1500 lm	○	0,3		39,24 €
5000	EHM15B	10,9 W	1520 lm	○	0,3		39,24 €
6000	EHM16B	10,9 W	1520 lm	○	0,5		39,24 €

Hat Micro

IP 20-54 | UGR 22



K	REF.	W	LUMEN				PVP (€)
3000	EHP03B	4,8 W	460 lm	○	0,5		22,11 €
4000	EHP04B	4,8 W	500 lm	○	0,5		22,11 €
5000	EHP05B	4,8 W	510 lm	○	0,5		22,11 €
6000	EHP06B	4,8 W	510 lm	○	0,5		22,11 €

Hat HR

Empotrado a techo

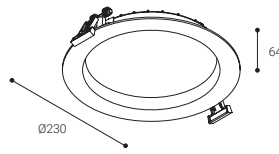

Distancia mínima de instalación a techo
94

	Rango de escotadura	Escotadura ideal
Hat HR	Ø210-225	Ø215 Corte redondo

EH1 | EH2/EHM/EHP | CRI | Δ | α
54000 h. | **72000 h.** | **>80** | **84°**
 L70B10 | L70B10

DIFUSOR MICROPRISMÁTICO

Hat HR

IP 20-54 | UGR 21



K	REF.	W	LUMEN	α	Δ	PVP (€)
3000	EHI13B	13 W	1500 lm	0,8	0,8	46,31 €
	EHI23B	20,5 W	2300 lm	0,8	0,8	51,87 €
4000	EHI14B	13 W	1600 lm	0,8	0,8	46,31 €
	EHI24B	20,5 W	2400 lm	0,8	0,8	51,87 €
5000	EHI15B	13 W	1625 lm	0,8	0,8	46,31 €
	EHI25B	20,5 W	2430 lm	0,8	0,8	51,87 €
6000	EHI16B	13 W	1625 lm	0,8	0,8	46,31 €
	EHI26B	20,5 W	2435 lm	0,8	0,8	51,87 €

Rendimiento (%)

Hat HR	75,1
--------	-------------

Seguridad fotobiológica
 RG0 **0** Exento de riesgo

- RAL9016
- RAL7001 Sustituir "B" por "G" en la referencia
- RAL9005 Sustituir "B" por "N" en la referencia

Hat Q

Empotrado a techo

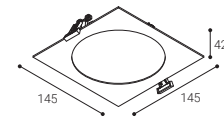
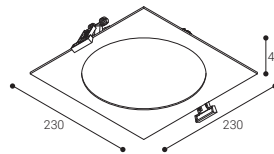

Distancia mínima de instalación a techo
94

	Rango de escotadura	Escotadura ideal
Hat Q	Ø200-225	Ø210 Corte redondo
Hat Mini Q	Ø125-150	Ø135 Corte redondo

72000 h. | CRI | Δ | EHQ | EHMQ
 L70B10 | **>80** | **84°** | **85°**

DIFUSOR MICROPRISMÁTICO

Hat Q

IP 20-54 | UGR 22



K	REF.	W	LUMEN	α	Δ	PVP (€)
3000	EHQ23B	20,5 W	2300 lm	0,8	0,8	52,92 €
4000	EHQ24B	20,5 W	2400 lm	0,8	0,8	52,92 €
5000	EHQ25B	20,5 W	2430 lm	0,8	0,8	52,92 €
6000	EHQ26B	20,5 W	2435 lm	0,8	0,8	52,92 €

Rendimiento (%)

Hat Q	75,1
Hat Mini Q	69,2

Seguridad fotobiológica
 RG0 **0** Exento de riesgo

- RAL9016
- RAL7001 Sustituir "B" por "G" en la referencia
- RAL9005 Sustituir "B" por "N" en la referencia

Hat Mini Q

IP 20-54 | UGR 22



K	REF.	W	LUMEN	α	Δ	PVP (€)
3000	EHMQ13B	10,9 W	1400 lm	0,3	0,3	39,24 €
4000	EHMQ14B	10,9 W	1500 lm	0,3	0,3	39,24 €
5000	EHMQ15B	10,9 W	1520 lm	0,3	0,3	39,24 €
6000	EHMQ16B	10,9 W	1520 lm	0,3	0,3	39,24 €

IR

Empotrado a techo

LED CE RoHS

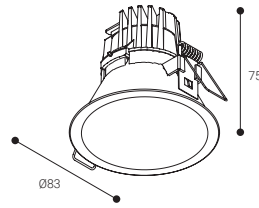

Escotadura ideal
IR **Ø79** Corte redondo

60000 h. L70B10 | CRI >80 | 60-61°

Rendimiento (%)
IR **91,9**

Seguridad fotobiológica
RG1+ **1** Bajo riesgo

* Tiempo inferior a 3 h. mirando fijamente a la fuente de luz

○ RAL9016
● RAL9005 Sustituir "B" por "N" en la referencia

SIN REGULACIÓN POR CORTE DE FASE

	K	REF.	W	LUMEN				PVP (€)
IP 20-54 UGR 19	3000	IR03STB	5,8 W	670 lm	○	0,1	20	39,43 €
	4000	IR04STB	5,8 W	700 lm	○	0,1	20	39,43 €

REGULABLE POR CORTE DE FASE

	K	REF.	W	LUMEN				PVP (€)
IP 20-54 UGR 19	3000	IR03TB	5,8 W	670 lm	○	0,1	20	43,99 €
	4000	IR04TB	5,8 W	700 lm	○	0,1	20	43,99 €

IQ

Empotrado a techo

LED CE RoHS

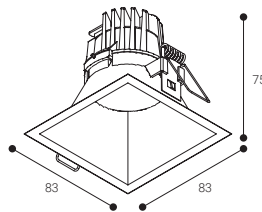

Escotadura ideal
IQ **79X79** Corte cuadrado

60000 h. L70B10 | CRI >80 | 60-63°

Rendimiento (%)
IR **91,3**

Seguridad fotobiológica
RG1+ **1** Bajo riesgo

* Tiempo inferior a 3 h. mirando fijamente a la fuente de luz

○ RAL9016
● RAL9005 Sustituir "B" por "N" en la referencia

SIN REGULACIÓN POR CORTE DE FASE

	K	REF.	W	LUMEN				PVP (€)
IP 20-54 UGR 19	3000	IQ03STB	5,8 W	670 lm	○	0,1	20	39,43 €
	4000	IQ04STB	5,8 W	700 lm	○	0,1	20	39,43 €

REGULABLE POR CORTE DE FASE

	K	REF.	W	LUMEN				PVP (€)
IP 20-54 UGR 19	3000	IQ03TB	5,8 W	670 lm	○	0,1	20	43,99 €
	4000	IQ04TB	5,8 W	700 lm	○	0,1	20	43,99 €

ACCESORIOS

Adaptador Ø85

	PVP (€)
○ IRAB	3,60 €
● IRAN	3,60 €

Adaptador 85x85

	PVP (€)
○ IQAB	3,60 €
● IQAN	3,60 €

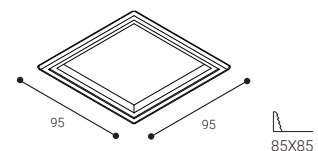
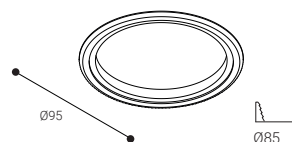

Tiny

Empotrado a techo

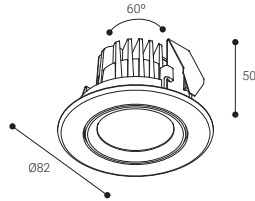

Distancia mínima de instalación a techo
94

Escotadura ideal
Tiny **Ø70** Corte redondo

60000 h. L70B10 | CRI >80 | 66°

Rendimiento (%)
Tiny **87,3**

Seguridad fotobiológica
RG1+ **1** Bajo riesgo

* Tiempo inferior a 3 h. mirando fijamente a la fuente de luz

- RAL9016
- RAL7001 Sustituir "B" por "G" en la referencia
- RAL9005 Sustituir "B" por "N" en la referencia

SIN REGULACIÓN POR CORTE DE FASE

	K	REF.	W	LUMEN				PVP (€)
IP 20 UGR 19	3000	T103SB	5,8 W	670 lm	○	0,1	10	31,82 €
	4000	T104SB	5,8 W	700 lm	○	0,1	10	31,82 €

REGULABLE POR CORTE DE FASE

	K	REF.	W	LUMEN				PVP (€)
IP 20 UGR 19	3000	T103B	5,8 W	670 lm	○	0,1	10	36,75 €
	4000	T104B	5,8 W	700 lm	○	0,1	10	36,75 €

Luzerna Avant

Empotrado a techo

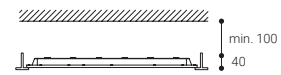
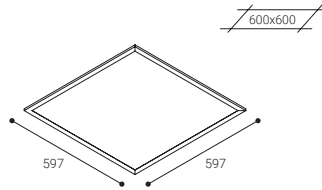

50000 h. L70B10 | CRI >80 | 91-114°

Rendimiento (%)	
Difusor PS	77,74
Difusor PMMA	70,9

Seguridad fotobiológica
RG0 Exento de riesgo

RAL9016

DIFUSOR PS TÉCNICO

600x600

IP 20-54 | UGR 19

K	REF.	W	LUMEN				PVP (€)
3000	LX33B	32 W	4320 lm	○	2,9	6	62,32 €
4000	LX34B	32 W	5140 lm	○	2,1	6	62,32 €
5000	LX35B	32 W	5140 lm	○	2,9	6	62,32 €

DIFUSOR PMMA MICROPRISMÁTICO

600x600

IP 20-54 | UGR 16

K	REF.	W	LUMEN				PVP (€)
3000	LX33GB	32 W	4320 lm	○	2,2	6	70,56 €
4000	LX34GB	32 W	5140 lm	○	2,2	6	70,56 €
5000	LX35GB	32 W	5140 lm	○	2,2	6	70,56 €



Empotrado a techo

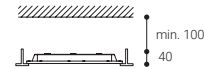
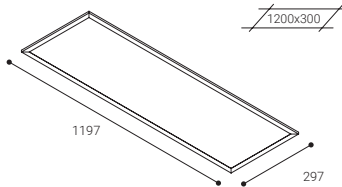

50000 h. L70B10 | CRI >80 | 91-114°

Rendimiento (%)	
Difusor PS	77,74
Difusor PMMA	70,9

Seguridad fotobiológica
RG0 Exento de riesgo

RAL9016

DIFUSOR PS TÉCNICO

1200x300

IP 20-54 | UGR 19

K	REF.	W	LUMEN				PVP (€)
3000	LX43B	32 W	4320 lm	○	2,9	6	77,46 €
4000	LX44B	32 W	5140 lm	○	2,9	6	77,46 €
5000	LX45B	32 W	5140 lm	○	2,9	6	77,46 €

DIFUSOR PMMA MICROPRISMÁTICO

1200x300

IP 20-54 | UGR 16

K	REF.	W	LUMEN				PVP (€)
3000	LX43GB	32 W	4320 lm	○	2,2	6	85,80 €
4000	LX44GB	32 W	5140 lm	○	2,2	6	85,80 €
5000	LX45GB	32 W	5140 lm	○	2,2	6	85,80 €

Luzerna Avant

Empotrado a techo

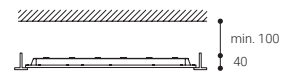
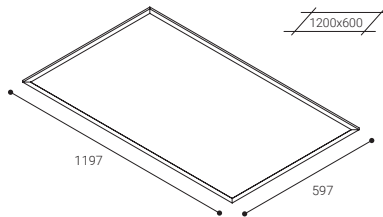

50000 h. L70B10 | CRI >80 | 91-114°

Rendimiento (%)	
Difusor PS	77,74
Difusor PMMA	70,9

Seguridad fotobiológica
 RG0 0 Exento de riesgo

RAL9016

DIFUSOR PS TÉCNICO

1200x600

IP 20-54 | UGR 19

K	REF.	W	LUMEN				PVP (€)
3000	LX53B	64 W	8640 lm	○	5,8	3	168,61 €
4000	LX54B	64 W	10280 lm	○	5,8	3	168,61 €
5000	LX55B	64 W	10280 lm	○	5,8	3	168,61 €

DIFUSOR PMMA MICROPRISMÁTICO

1200x600

IP 20-54 | UGR 16

K	REF.	W	LUMEN				PVP (€)
3000	LX53GB	64 W	8640 lm	○	2,2	3	185,19 €
4000	LX54GB	64 W	10280 lm	○	2,2	3	185,19 €
5000	LX55GB	64 W	10280 lm	○	2,2	3	185,19 €

ACCESORIOS

Kit para instalación empotrada en escayola

		PVP (€)
LX3M	600X600	36,65 €
LX4M	1200X300	49,46 €
LX5M	1200X600	59,33 €

Kit para instalación suspendida

		PVP (€)
LXKS	Todos los modelos	25,62 €

Kit para instalación en superficie

		PVP (€)
LXSE3B	600X600	33,08 €
LXSE4B	1200X300	43,58 €
LXSE5B	1200X600	54,08 €

Block Avant

- Suspendido a techo
- Adosado a techo/pared

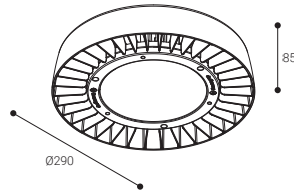

ÓPTICA INTENSIVA

50000 h. L70B10 | CRI >80 | 60-120° | IK 07-08 | 4 kV

Seguridad fotobiológica
RG1+ 1 Bajo riesgo

* Tiempo inferior a 3 h. mirando fijamente a la fuente de luz

● RAL9011 TEXTURIZADO

IP 67 | UGR 22



K	REF.	W	LUMEN			PVP (€)
4000	BK100-4SN	90,9 W	15000 lm	● 4,1		201,06 €
	BK150-4SN	136,4 W	22500 lm	● 4,1		226,09 €
	BK200-4SN	181,8 W	30000 lm	● 4,1		261,21 €
5700	BK100-5SN	90,9 W	15030 lm	● 4,1		201,06 €
	BK150-5SN	136,4 W	22550 lm	● 4,1		226,09 €
	BK200-5SN	181,8 W	30070 lm	● 4,1		261,21 €

ÓPTICA MEDIA

IP 67 | UGR 22

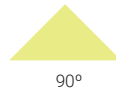

K	REF.	W	LUMEN			PVP (€)
4000	BK100-4MN	90,9 W	15000 lm	● 4,1		201,06 €
	BK150-4MN	136,4 W	22500 lm	● 4,1		226,09 €
	BK200-4MN	181,8 W	30000 lm	● 4,1		261,21 €
5700	BK100-5MN	90,9 W	15030 lm	● 4,1		201,06 €
	BK150-5MN	136,4 W	22550 lm	● 4,1		226,09 €
	BK200-5MN	181,8 W	30070 lm	● 4,1		261,21 €

ÓPTICA EXTENSIVA

IP 67 | UGR 22

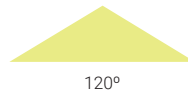

K	REF.	W	LUMEN			PVP (€)
4000	BK100-4FN	90,9 W	15000 lm	● 4,1		201,06 €
	BK150-4FN	136,4 W	22500 lm	● 4,1		226,09 €
	BK200-4FN	181,8 W	30000 lm	● 4,1		261,21 €
5700	BK100-5FN	90,9 W	15030 lm	● 4,1		201,06 €
	BK150-5FN	136,4 W	22550 lm	● 4,1		226,09 €
	BK200-5FN	181,8 W	30070 lm	● 4,1		261,21 €

ACCESORIOS

	COLOR	PVP (€)
BK060L	Lente ángulo de apertura 60°	8,45 €
BK090L	Lente ángulo de apertura 90°	8,45 €
BK120L	Cristal transparente ángulo de apertura 120°	8,45 €
BK060R	Reflector ángulo de apertura 60°	Ⓐ 28,20 €
BK090R	Reflector ángulo de apertura 90°	Ⓐ 28,20 €
BKLN	Lira para instalación adosada	● 13,91 €
1029L2VP	Accesorio de suspensión de 2 metros de longitud	13,31 €
1029L4VP	Accesorio de suspensión de 4 metros de longitud	19,58 €
REGBORTEK2UI	Conector lineal estanco IP68 de 2 polos	Consultar

BK060L
BK090L
BK120L

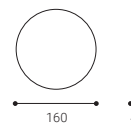

BK060R
BK090R

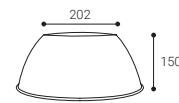

1029L2VP
1029L4VP



BKLN

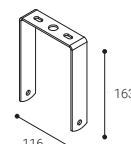

Hermetic Avant

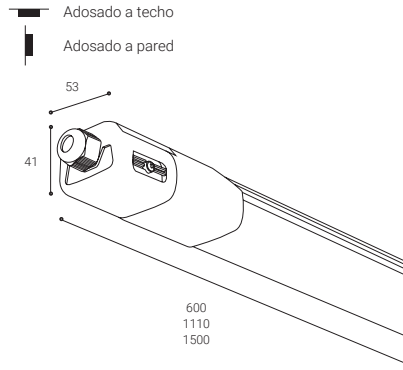

54000 h. L70B10 | CRI >80 | 135° | IK 08

Rendimiento (%)
Hermetic Avant 80

Seguridad fotobiológica
RGD 0 Exento de riesgo

○ RAL9016

6000K Disponibles modelos en temperatura de color 6000K. Añadir referencia "-6"

Versión con sensor de presencia. Referencia "+S"

DIFUSOR OPAL

600 mm

	K	REF.	W	LUMEN			PVP (€)
IP 66 UGR 22	4000	DV18	17,8 W	2250 lm	○	0,3	30,25 €
		DV18S	17,8 W	2250 lm	○	0,3	52,25 €

1110 mm

	K	REF.	W	LUMEN			PVP (€)
IP 66 UGR 22	4000	DV36	32,4 W	4500 lm	○	0,5	43,25 €
		DV36S	32,4 W	4500 lm	○	0,5	65,25 €

1500 mm

	K	REF.	W	LUMEN			PVP (€)
IP 66 UGR 22	4000	DV60	54 W	7500 lm	○	0,6	53,25 €
		DV60S	54 W	7500 lm	○	0,6	80,00 €

Número máximo de luminarias según modelo

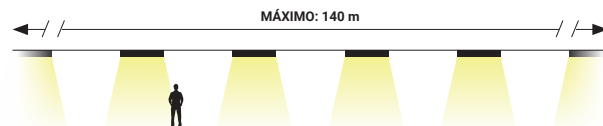

	MÁXIMO UNIDADES	POTENCIA MÁX. TOTAL
DV18 / DV18S	22	396 W
DV36 / DV36	11	396 W
DV60 / DV60S	7	420 W

140 metros de longitud máxima de conexión en línea, para un cable de 1,5 mm de sección.

Silk

 Carril electrificado

 LED   

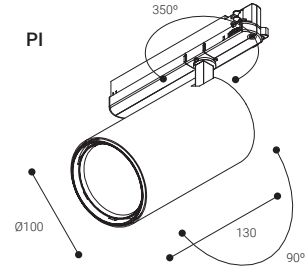
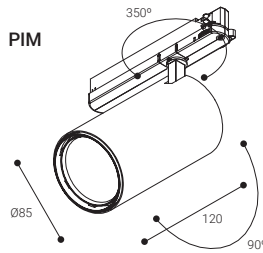

 **60000 h.**
L80B10

CRI >90

 **15-55°**

Rendimiento (%)	
Silk	87

Seguridad fotobiológica

RG1*  **Bajo riesgo**



* Tiempo inferior a 3 h. mirando fijamente a la fuente de luz

- RAL9016
- RAL9005 Sustituir "B" por "N" en la referencia

ÓPTICA INTENSIVA

IP 20 | UGR 22





K	REF.	W	LUMEN			PVP (€)
2700	PIM22SB	22 W	2340 lm	○	0,7	117,75 €
3000	PIM23SB	22 W	2520 lm	○	0,7	117,75 €
4000	PIM24SB	22 W	2715 lm	○	0,7	117,75 €
2700	PI32SB	29,6 W	2940 lm	○	0,8	122,25 €
3000	PI33SB	29,6 W	3170 lm	○	0,8	122,25 €
4000	PI34SB	29,6 W	3410 lm	○	0,8	122,25 €

ÓPTICA MEDIA

IP 20 | UGR 22





K	REF.	W	LUMEN			PVP (€)
2700	PIM22MB	22 W	2340 lm	○	0,7	117,75 €
3000	PIM23MB	22 W	2520 lm	○	0,7	117,75 €
4000	PIM24MB	22 W	2715 lm	○	0,7	117,75 €
2700	PI32MB	29,6 W	2940 lm	○	0,8	122,25 €
3000	PI33MB	29,6 W	3170 lm	○	0,8	122,25 €
4000	PI34MB	29,6 W	3410 lm	○	0,8	122,25 €

ÓPTICA EXTENSIVA

IP 20 | UGR 22



K	REF.	W	LUMEN			PVP (€)
2700	PIM22FB	22 W	2340 lm	○	0,7	117,75 €
3000	PIM23FB	22 W	2520 lm	○	0,7	117,75 €
4000	PIM24FB	22 W	2715 lm	○	0,7	117,75 €
2700	PI32FB	29,6W	2940 lm	○	0,8	122,25 €
3000	PI33FB	29,6W	3170 lm	○	0,8	122,25 €
4000	PI34FB	29,6W	3410 lm	○	0,8	122,25 €

ÓPTICA MUY EXTENSIVA

IP 20 | UGR 22



K	REF.	W	LUMEN			PVP (€)
2700	PIM22WB	22 W	2340 lm	○	0,7	117,75 €
3000	PIM23WB	22 W	2520 lm	○	0,7	117,75 €
4000	PIM24WB	22 W	2715 lm	○	0,7	117,75 €
2700	PI32WB	29,6W	2940 lm	○	0,8	122,25 €
3000	PI33WB	29,6W	3170 lm	○	0,8	122,25 €
4000	PI34WB	29,6W	3410 lm	○	0,8	122,25 €

Avalon

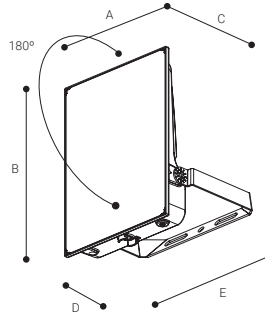
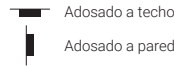

REFS.	mm				
	A	B	C	D	E
AV10.../AV20...	136	120	121	43,5	149
AV30.../AV50...	174	146	129	46	197
AV65...	154	205	159	47	175
AV80...	194	250	166	49	214
AV125...	229	275	176	53	252
AV165...	244	315	216	58	252
AV200...	276	357	238	62	303

54000 h. L70B10 | CRI >80 | 108°

Rendimiento (%)
Avalon **92,1**

Seguridad fotobiológica
RG1* | 1 Bajo riesgo

* Tiempo inferior a 3 h. mirando fijamente a la fuente de luz

- RAL9005
- RAL9016 Sustituir "N" por "B" en la referencia

6500K Disponibles modelos en temperatura de color 6500K. Sustituir "3FN" o "4FN" por "6FN"

ESTÁNDAR

K	REF.	W	LUMEN	Beam	UGR	PVP (€)
3000	AV10-3FN	9 W	1250 lm	● ○	0,8	27,90 €
	AV20-3FN	18 W	2620 lm	● ○	0,8	29,15 €
	AV30-3FN	27 W	4030 lm	● ○	1,2	45,10 €
	AV50-3FN	45 W	6270 lm	● ○	1,2	51,35 €
	AV65-3FN	58,5 W	8219 lm	● -	1,6	129,00 €
	AV80-3FN	72 W	10520 lm	● -	2,3	170,00 €
	AV125-3FN	112,5 W	16010 lm	● -	3,2	270,00 €
	AV165-3FN	148,5 W	21290 lm	● -	3,7	309,00 €
	AV200-3FN	180 W	25280 lm	● -	4,6	370,00 €
	4000	AV10-4FN	9 W	1330 lm	● ○	0,8
AV20-4FN		18 W	2820 lm	● ○	0,8	29,15 €
AV30-4FN		27 W	4210 lm	● ○	1,2	45,10 €
AV50-4FN		45 W	6390 lm	● ○	1,2	51,35 €
AV65-4FN		58,5 W	8550 lm	● -	1,6	129,00 €
AV80-4FN		72 W	10940 lm	● -	2,3	170,00 €
AV125-4FN		112,5 W	17530 lm	● -	3,2	270,00 €
AV165-4FN		148,5 W	23260 lm	● -	3,7	309,00 €
AV200-4FN		180 W	26030 lm	● -	4,6	370,00 €

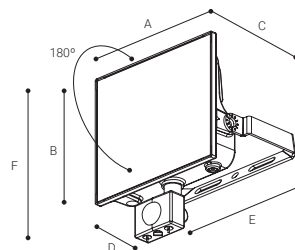

REFS.	mm					
	A	B	C	D	E	F
AV10S.../AV20S...	136	120	121	43,5	149	185
AV30S.../AV50S...	174	146	129	46	197	210

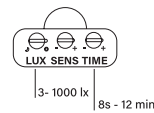

SENSOR DE PRESENCIA

54000 h. L70B10 | CRI >80 | 108°

Rendimiento (%)
Avalon **92,1**

Seguridad fotobiológica
RG1* | 1 Bajo riesgo

* Tiempo inferior a 3 h. mirando fijamente a la fuente de luz

- RAL9005 Sustituir "B" por "N" en la referencia

K	REF.	W	LUMEN	Beam	UGR	PVP (€)
3000	AV10S-3FN	9 W	1250 lm	● ○	0,8	44,70 €
	AV20S-3FN	18 W	2620 lm	● ○	0,8	46,45 €
	AV30S-3FN	27 W	4030 lm	● ○	1,2	65,75 €
	AV50S-3FN	45 W	6270 lm	● ○	1,2	87,05 €
4000	AV10S-4FN	9 W	1330 lm	● ○	0,8	44,70 €
	AV20S-4FN	18 W	2820 lm	● ○	0,8	46,45 €
	AV30S-4FN	27 W	4210 lm	● ○	1,2	65,75 €
	AV50S-4FN	45 W	6390 lm	● ○	1,2	87,05 €



Características de los materiales

Las medidas, pesos, características o magnitudes que se muestran en esta tarifa-catálogo o en cualquier otro medio de Normagrup Technology, S.A. son orientativas y podrán verse modificadas sin notificación previa.

Precios y entregas

Los Precios de Venta al Público (PVP) incluidos en esta tarifa son Precios recomendados de Venta al Público en Euros (€) y que no incluyen IVA.

Los precios indicados en esta tarifa incluyen ECOTASA.

Los precios incluidos en esta tarifa son válidos **únicamente para España**.

Los precios de venta serán ofertados por escrito o aquellos que se contemplen en nuestra tarifa en vigor en el momento en el que se realice el suministro.

El suministro de mercancías se realizará por unidades completas de embalaje.

Pedido mínimo

Se establece un pedido con un importe mínimo de 100 € netos.

Portes pagados

Se suministrarán libres de portes aquellos pedidos cuyo importe sea igual o superior a 430 € netos y cuyo destino sea la península o Baleares, siempre y cuando, dichos materiales viajen por los medios definidos por Normagrup Technology, S.A.

En caso de que los pedidos tengan un importe inferior a 430 € netos, dichos pedidos se suministrarán libres de portes con un cargo adicional de 25 € netos en concepto de gestión y portes, o bien sin cargo adicional a portes debidos.

Portes debidos

Todos aquellos pedidos definidos como especiales, serán enviados a portes debidos independiente de su importe. Igualmente se enviarán en estas condiciones los pedidos que sean expresamente solicitados a portes debidos por el cliente o bien todos aquellos en los que el medio de transporte sea diferente al seleccionado por Normagrup Technology, S.A.

Condiciones de suministro en Canarias

Se establece un pedido mínimo de importe 630 €.

Incidencias en los envíos

Se considera imprescindible que toda la mercancía enviada sea revisada y comprobada dentro de las 24 horas siguientes a la recepción del material. En caso de detectarse alguna incidencia deberá ser comunicada de forma inmediata a la agencia de transporte o bien a los teléfonos de atención al cliente de Normagrup Technology, S.A.

Material consignado a terceros

Si el cliente solicita la entrega de la mercancía en un destino distinto al de su domicilio habitual, deberá contar con una conformidad previa de Normagrup Technology, S.A. De igual forma, el cliente deberá responsabilizarse de la recepción y comprobación en las mismas condiciones de su dirección habitual.

Devoluciones

Las devoluciones de mercancías solo se aceptarán si son gestionadas durante un plazo máximo de 30 días desde el momento del suministro. Los productos cubiertos por la garantía están exentos de este plazo de 30 días.

Cualquier devolución, solo será aceptada si cuenta con la conformidad previa expresa de Normagrup Technology, S.A. En ese caso, el material será enviado a nuestros almacenes centrales en Asturias siguiendo el procedimiento establecido. Diríjase a nosotros por correo electrónico a la dirección **rma@normagrup.com** o bien a través del teléfono a nuestro número **985 267 100**.

Validez de los precios

Los precios en esta tarifa anulan cualquier otro precio publicado anteriormente por Normagrup Technology, S.A. y son válidos con la excepción de errores de impresión.

Responsabilidad civil





































La responsabilidad civil sobre nuestros productos caduca al año del suministro. Normagrup Technology, S.A. declina toda la responsabilidad debida al uso inadecuado de sus productos.

En caso de litigio como consecuencia de una venta, las partes se someterán a la jurisdicción de los tribunales de Oviedo, renunciando ambas partes a cualquier otro fuero que pudiera corresponderles.

Garantía

Todos los productos de esta publicación tienen una garantía de tres años en caso de defectos de fabricación, según la nueva norma sobre bienes de consumo que entró en vigor a partir del 1 de enero de 2022. La garantía no cubre fallos causados por un uso o manipulación indebida. La garantía no cubre elementos reemplazables. En el caso de ser necesario ejecutar esta garantía, debe dirigirse al distribuidor donde se haya realizado la compra presentando la factura, así como una descripción pormenorizada del defecto de funcionamiento apreciado.

Iconografía / Leyenda

 Clase I	Instalación	Rango lumínico	Versiones	Baterías	Alimentación	Normativa
 Clase II	 Adosada techo	 Lm XXX-XXX	 Autotest	 Ni-Cd Ni-Cd	 24 Vdc	 EN XXXXX
 Clase III	 Carril electrificado	Autonomía	 Dali	 Ni-Cd / Ni-MH	 230 Vac	Distancia máxima de visión
 Comunidad Europea	 Adosada techo lamas	 X	 Dali 2	 Litio	Bajas temperaturas	 XX m
 Ensayo del hilo incandescente 850°	 Empotrada techo	Modos de funcionamiento	 Inteligente Wireless	 Plomo	 -25°C	Sistema enchufable de conexión rápida
LED Lámpara LED	 Suspendida	 Permanente	 Central Battery System	IP IK		Detector de presencia
	 Adosada pared	 No permanente	 SATI SATI	 IP XX		
	 Empotrada pared	 Permanente / No Permanente	 SATI addressable	 IK XX		

NORMALUX

Alumbrado de emergencia
normalux.es

NORMALIT

Iluminación técnica y arquitectónica
normalit.es

Un servicio para profesionales



Relación
calidad-precio



Departamento de ofertas
y proyectos a medida



Soporte técnico
personalizado



Entrega rápida



Catálogo
exclusivo



Garantía
post venta



Normagrup Technology
Sede central / Headquarter
Parque Tecnológico de Asturias. C/Ablanal, 1
33428 Llanera (Asturias). España / Spain

Normagrup UK
Normagrup Netherlands
Normagrup France
Normagrup México

normagrup.com



Normagrup